

01

**IKM AHF/SVG
Product Introduction**



1.1 IKM AHF/SVG Key Differences

SIMILARITIES

- The external dimensions of AHF and SVG are the same. Standardized modules make production more efficient and convenient to use.
- The monitoring touch screen interface of AHF and SVG is the same.
- AHF and SVG have the ability to simultaneously compensate for harmonics, reactive power, and regulate three-phase unbalanced current.
- The internal structure is the same.



VS

DIFFERENCES

- Different application scenarios. AHF is mainly used for filtering while SVG is mainly used for compensating reactive power, and they are applied in different situations with different requirements.
- The selection and control procedures of internal components are different. Because the main functions of the two are different, they target different current frequencies.
- There are differences in filtering range and capability. AHF can filter out 2-50 harmonics, while SVG can only filter out 2-25 harmonics. AHF has better filtering performance
- There are differences in parameter settings. SVG is generally set to compensate for reactive power priority by default; AHF is generally set to compensate for harmonics first by default.



1.2 IKM AHF/SVG Compensation Principle

WORKING PRINCIPLE

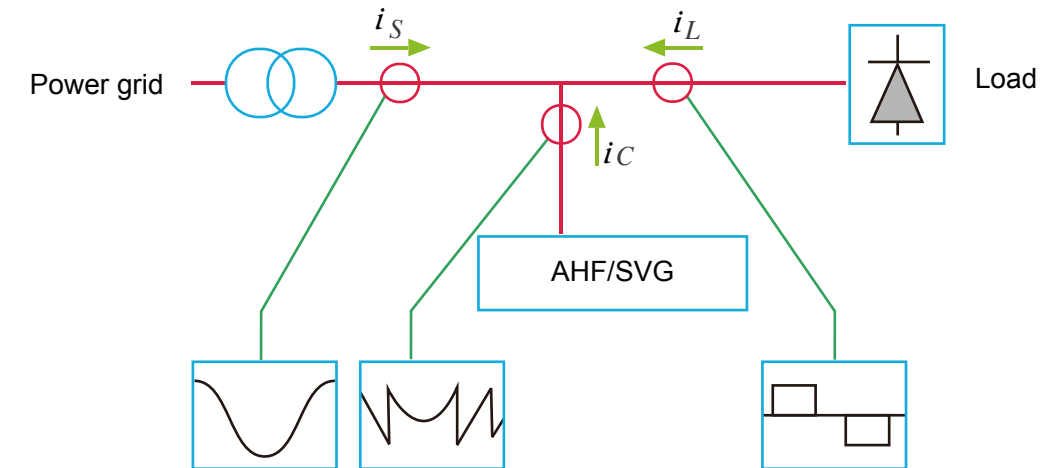

Compensation schematic diagram

HARMONIC GOVERNANCE

AHF/SVG collects current signals in real time through external current transformers, separates the harmonic components through internal detection circuits, and generates compensation currents that are equal in size and opposite in phase to the harmonics in the system through IGBT power converters, achieving the function of filtering out harmonics.

REACTIVE POWER COMPENSATION

AHF/SVG generates capacitive or inductive fundamental currents through IGBT power converters based on the reactive power of the system, achieving the purpose of dynamic reactive power compensation. The compensation target value can be set through the operation panel, without overcompensation, and the compensation is smooth, without causing inrush current impact on the load and power grid.

ADJUSTING THREE-PHASE CURRENT IMBALANCE

AHF/SVG extracts the unbalanced component based on the system current, and the three-phase sends out a current that is equal in size and opposite in phase to the unbalanced component. By compensating the unbalanced part to zero, the three-phase unbalanced current on the grid side can be corrected to three-phase balanced current.

CONTROL PRINCIPLE

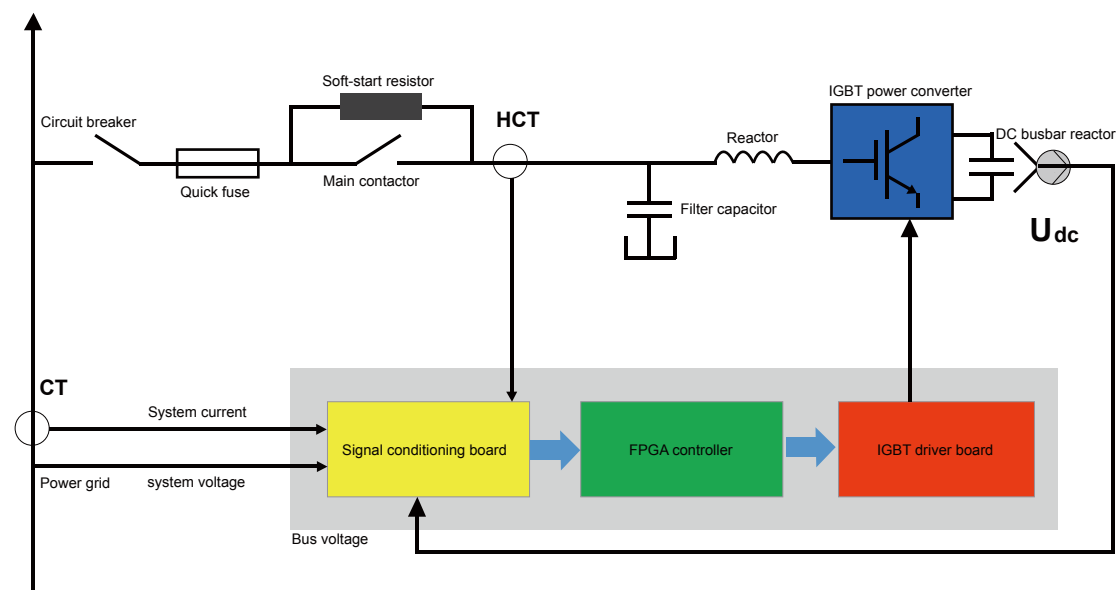

Internal control schematic diagram

After the circuit breaker is closed, in order to prevent the instantaneous impact of the power grid on the DC bus capacitor during power on, AHF/SVG first charges the DC bus through a soft start circuit. When the bus voltage U_{dc} reaches the predetermined value, the main contactor closes. As an energy storage device, DC capacitors provide energy by outputting compensating current through IGBT inverters and internal reactors. AHF/SVG collects current signals in real-time through external CT and sends them to the signal conditioning circuit, which then sends them to the controller. The controller decomposes the sampled current, extracts each harmonic current, reactive current, and three-phase unbalanced current, compares the collected current component to be compensated with the compensation current sent by AHF/SVG to obtain the difference, and outputs it as a real-time compensation signal to the driving circuit. The IGBT converter is triggered to inject the compensation current into the power grid, achieving closed-loop control and completing the compensation function.

1.3 IKM AHF/SVG Features



GENERAL FEATURES

- AHF and SVG adopt modular standard design. Different capacity modules can be freely matched, making installation and maintenance convenient, Each module operates independently, automatically exiting after any module fails, while the other modules continue to operate, resulting in higher reliability.
- The compensation model is flexible and convenient, with strong comprehensive governance capabilities. Reactive power, harmonic, and imbalance compensation can be freely selected, and priority levels can be set.
- AHF can compensate for 2-50 harmonics, SVG can compensate for 2-25 harmonics, and specific harmonic compensation can be selected.
- Bidirectional dynamic reactive power regulation, with a power factor that can be compensated to 0.99.
- Fast response speed, response time $\leq 10\text{ms}$.
- It can be equipped with an external 7-inch centralized monitoring touch screen, and has a friendly human computer interface to view real-time power quality information.
- A single monitoring screen can monitor 12 modules. If there are more than 12 modules in a single system, increasing the number of touch screens is sufficient, and the number of parallel machines is not limited.
- During the compensation process, the module's operating status can be automatically detected in real-time, and self diagnosis can be restarted in case of a fault. If the fault is eliminated, it will be automatically put into use.
- The module has comprehensive and comprehensive protection functions such as overvoltage, undervoltage, and overcurrent temperature.
- Equipped with IGBT temperature monitoring function, when the temperature exceeds the design limit of the software the module will automatically derate for use, effectively protecting the normal operation of the module.

CORE ADVANTAGES

- **Industry First Layered Closure Technology**
Electronic components and power devices are designed in layers, and the electronic layer is fully enclosed. The protection level standard is IP42, and customization can reach IP54, without fear of harsh environments such as dust, high temperature, humidity, salt and alkali.
- **The Seventh generation IGBT**
Significantly increase the switching frequency and reduce losses by one-third.
- **FPGA control**
Adopting full FPGA chip control, completely replacing DSP; FPGA uses hardware logic gates for programming, with no risk of stack overflow and high reliability.
- **Extremely high switching frequency**
Using quasi natural sampling and continuous control, the equivalent switching frequency reaches 80kHz, the current loop width reaches 4kHz, and the interference suppression speed reaches more than four times that of other products in the same industry. The mainstream indicators in the industry are 20kHz/1kHz, respectively.
- **Extremely low loss**
When working at full load, the active power loss is $< 2.5\%$ which is lower than the mainstream industry indicator of 3%-4%. Save electricity costs for users.
- **Extremely low noise**
When the entire machine is operating at full load, the noise is $\leq 60\text{dB}$, which is lower than the mainstream industry indicator of 70dB. Provide users with a better user experience
- **Extremely high power density**
800*800mm standard low-voltage distribution cabinet, with AHF power up to 800A and SVG up to 600kvar. Reduce installation space, save floor space, and reduce costs for users.



1.4 IKM AHF/SVG Technical Parameters Table

Category	Project	Power Quality Product (Silicon Carbide Customizable)																	
Name	Product Name	SVG (kvar)						AHF (A)											
Specification	Voltage level	400V						480V				690V				800V			
	Module Specifications	30	50	100	150	40/80	50/100	100/135	35	50	75	100	150	200	50/100	75/100			
	Module size (W*H*D) (Note 1)	480*130*440	√						√										
		480*200*530		√						√	√								
		680*200*530		√	√	√				√	√	√	√	√					
		680*200*550					√	√	√						√	√			
	The maximum capacity of a single cabinet	600*600	200						300										
		600*800	300						600										
		800*800	600						400				500				675		
	Number of parallels	12																	
Input	Operating voltage	220V (176V-264V)						400V (304V-456V)				690V (380V-750V)				800V (680V-920V)			
	Operating frequency	50Hz/60Hz (-10% ~ +10%)																	
	Current transformers	100 : 5 ~ 10000 : 5																	
Function	Controller	100% Full FPGA, 16 CPUs parallel computation																	
	Compensate for harmonics	2-25th						2-50th											
	Efficiency	>97.5%																	
	Compensates for reactive power	-1~+1adjustable (Within the capacity of the device)																	
	Compensates for Three-phase imbalance	100% The imbalance is fully compensated (690V No compensation for three-phase unbalance function)																	
	Switching Frequency	80khz (7th Generation Infineon IGBT)																	
Communication Protocols	Methods of Communication	RS485, Modbus RTU, Wifi (Remote control debugging)																	
	Host computer software	Yes, all parameters can be set by the host computer																	
	Fault alarm	Yes, up to 500 alarm messages can be recorded																	
	Monitor	Support independent monitoring of each module/centralized monitoring of the whole machine																	
Technical Indicators	Full response time	≤10ms , instant response <100us																	
	Active loss	≤2.5%																	
	Heat dissipation	Intelligent air cooling																	
	Noise	≤60dB																	
	Protection features	There are more than 20kinds of protection such as overvoltage, undervoltage, overheating, overcurrent, short circuit, etc																	
	CT Installation location	Load side/grid side Optional																	
Mechanical Properties	Wall mount size	The wall mount is the same size as the module																	
	Module weight	17.5kg (30k/35A) ; 26kg (480W50k/50A/75A/100A) ; 32kg (680W50k/50A/75A) ; 38.5kg (680W100k/100A/150A) ; 45.5kg (150k/200A);																	
	Color	7035 Fine orange texture spray painted																	
Environmental Requirements	Operating temperature	-20°C~+55°C																	
	Elevation	<5000meters (More than 1000 meters, For every 100 meters of additional elevation, the power is reduced by 1%.)																	
	Relative humidity	<95%, No condensation																	
	Ingress protection	Module IP20 + Electronic Layer IP42 (Customizable IP54 or IP65)																	
Pollution resistance rating	Level 2 (Customizable level 3)																		

Note1: The opening ratio and fan specifications of the front and rear doors of the cabinet should meet the specifications specified by our company and keep the ventilation good.

1.5 IKM AHF/SVG Model Description

AHF Model Description

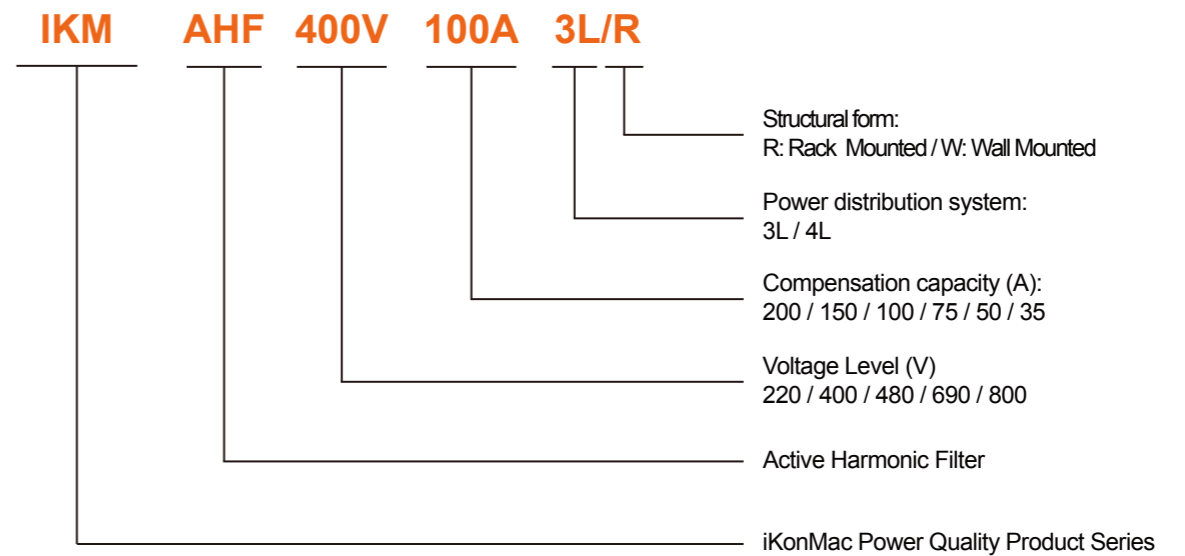

SVG Model Description

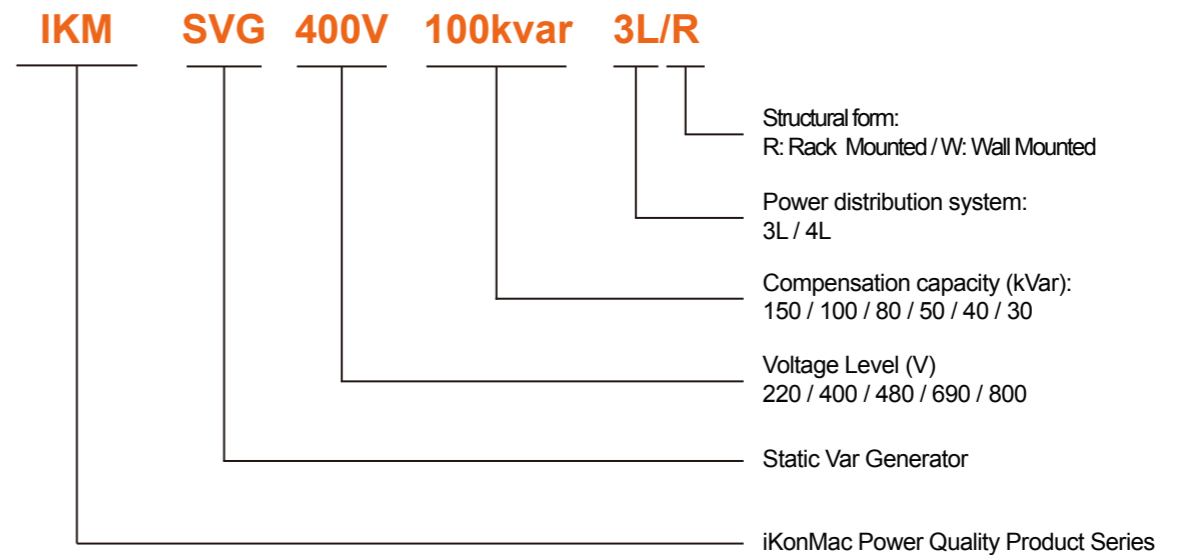

1.6 IKM AHF/SVG Capacity Configuration Scheme

Capacity Determination of AHF Active Filter

Based on the experience of the power quality industry, two formulas are commonly used to estimate the capacity of harmonic suppression.

(1) Centralized governance: Estimate the configuration capacity of harmonic governance based on industry classification and transformer capacity.

$$I_h = \frac{S \times K}{\sqrt{3} \times U \times \sqrt{1 + THD_i^2}} \times THD_i$$

S — Transformer rated capacity **U** — Rated voltage on the secondary side of the U-transformer

I_h — Harmonic current **THD_i** — Total current distortion rate, with a range of values determined based on different industries or loads

K — Transformer load rate

Industry type	Typical harmonic distortion rate %
Subways, Tunnels, High-speed trains, Airports	15%
Communication, Commercial buildings, Banks	20%
Medical Industry	25%
Automobile manufacturing, Ship manufacturing	30%
Chemical / Petroleum	35%
Matallurgical Industry	40%

(2) On site governance: Estimate the configuration capacity of harmonic governance based on different load devices.

$$I_h = K \times I_N \times \frac{THD_i}{\sqrt{1 + THD_i^2}}$$

I_h — Harmonic current **THD_i** — Total current distortion rate, with a range of values determined based on different industries or loads

K — Transformer load rate

Load type	Typical harmonic content %	Load type	Typical harmonic content %
Inverter	30~50	Medium frequency induction heating power supply	30~35
Elevator	15~30	Six pulse rectifier	28~38
LED Lights	15~20	Twelve pulse rectifier	10~12
Energy saving lamp	15~30	Electric welding machine	25~58
Electronic ballast	15~18	Variable frequency air conditioning	6~34
Switching Mode Power Supply	20~30	UPS	10~25

Note: The above calculations are only estimation formulas and have a certain error

Determination of SVG reactive power compensation capacity

(1) Estimate based on transformer capacity:

20% to 40% of the transformer capacity is used to configure reactive power compensation capacity, with a general selection of 30%

$$Q_{\text{compensate}} = 30\% \times S$$

Q_{compensate} — Reactive power compensation capacity **S** — Transformer capacity

For example, a 1000kVA transformer is equipped with 300kvar reactive power compensation

(2) Calculate based on the power factor and active power of the equipment:

If there are detailed load parameters, such as maximum active power P, power factor COSθ before compensation, and target power factor COSθ after compensation, the actual compensation capacity required for the system can be directly calculated:

$$Q_{\text{compensate}} = K \times P \times (\tan \theta_1 - \tan \theta_2)$$

Q_{compensate} — Reactive power compensation capacity **P** — Maximum active power

K — Average load coefficient (generally taken as 0.7-0.8)

Note: The above calculations are for reference only.

1.7 IKM AHF/SVG Quick Selection Table

● AHF Quick Selection Table

Transformer capacity	AHF Capacity configuration	AHF Capacity configuration
Scope of application	Commercial plazas, Office buildings, Financial Towers, Hotels, Theaters, Data Centers, Hospitals, Banks, Schools and other light-load occasions	Petrochemical, Mining and Metallurgy, Automobile Manufacturing, Shipbuilding and heavy industry, Sewage treatment, Port terminals, Rail transit, Food processing, Papermaking, Textile printing and dyeing, Material processing!
200kVA	35A	50A
250kVA/315kVA	50A	75A
400kVA/500kVA	75A	100A
630kVA/800kVA	100A	150A
1000kVA	150A	200A (100A*2)
1250 kVA	200A (100A*2)	250A (150A +100A)
1600 kVA	250A (150A+100A)	300A (150A*2)
2000 kVA	300A (150A*2)	400A (150A*2+100A)
2500 kVA	400A (150A*2+100A)	500A (150A*2+100A*2)

● SVG Quick Selection Table

Transformer capacity	SVG Capacity configuration				
	$\text{Cos}\theta \leq 0.5$	$0.5 \leq \text{Cos}\theta \leq 0.6$	$0.6 \leq \text{Cos}\theta \leq 0.7$	$0.7 \leq \text{Cos}\theta \leq 0.8$	$0.8 \leq \text{Cos}\theta \leq 0.9$
200kVA	100kvar	100kvar	100kvar	100kvar	100kvar
250kVA	150kvar	100kvar	100kvar	100kvar	100kvar
315kVA	200kvar	100kvar	100kvar	100kvar	100kvar
400kVA	200kvar	200kvar	200kvar	150kvar	100kvar
500kVA	300kvar	300kvar	300kvar	150kvar	100kvar
630kVA	300kvar	300kvar	300kvar	200kvar	150kvar
800kVA	500kvar	500kvar	300kvar	300kvar	150kvar
1000kVA	300kvar	500kvar	500kvar	300kvar	200kvar
1250kVA	700kvar (300kvar+400kvar)	600kvar	600kvar	500kvar	300kvar
1600kVA	800kvar (400kvar*2)	800kvar (400kvar*2)	800kvar (400kvar*2)	500kvar	300kvar
2000kVA	1000kvar (500kvar*2)	1000kvar (500kvar*2)	1000kvar (400kvar*2)	600kvar	300kvar
2500kVA	1500kvar (500kvar*3)	1300kvar (500kvar*2+300kvar)	1000kvar (500kvar*2)	800kvar (400kvar*2)	500kvar

1.8 IKM AHF/SVG Product Dimensions

680 Width Rack Type Module Dimension Diagram (100/150kvar 150/200A)

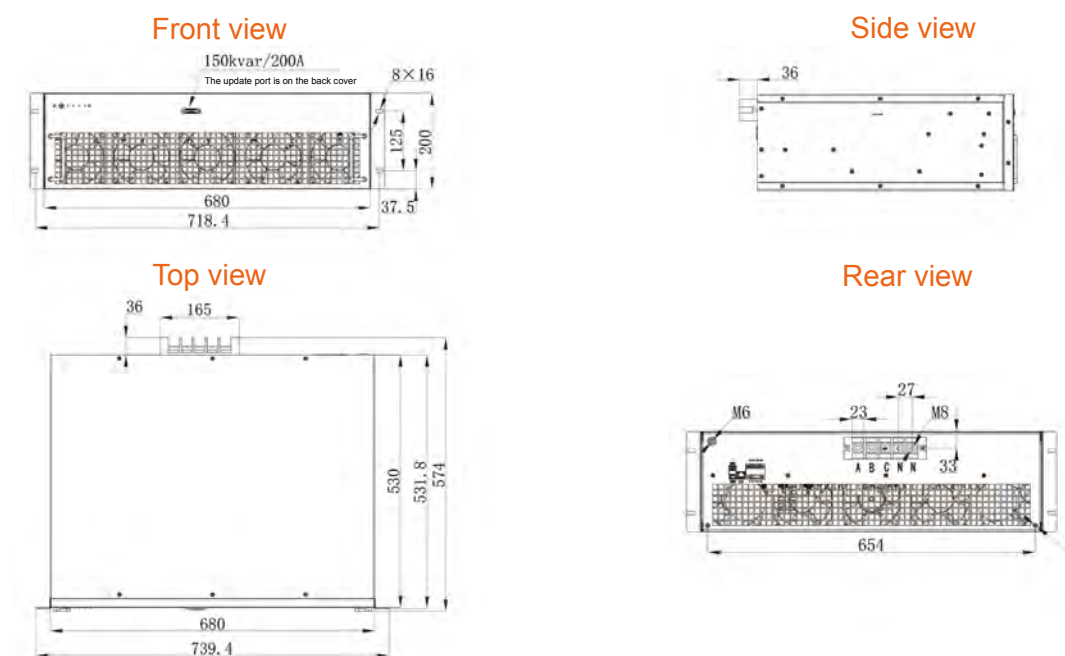

680 Width Rack Type Module Dimension Diagram (50kvar 50/75A)

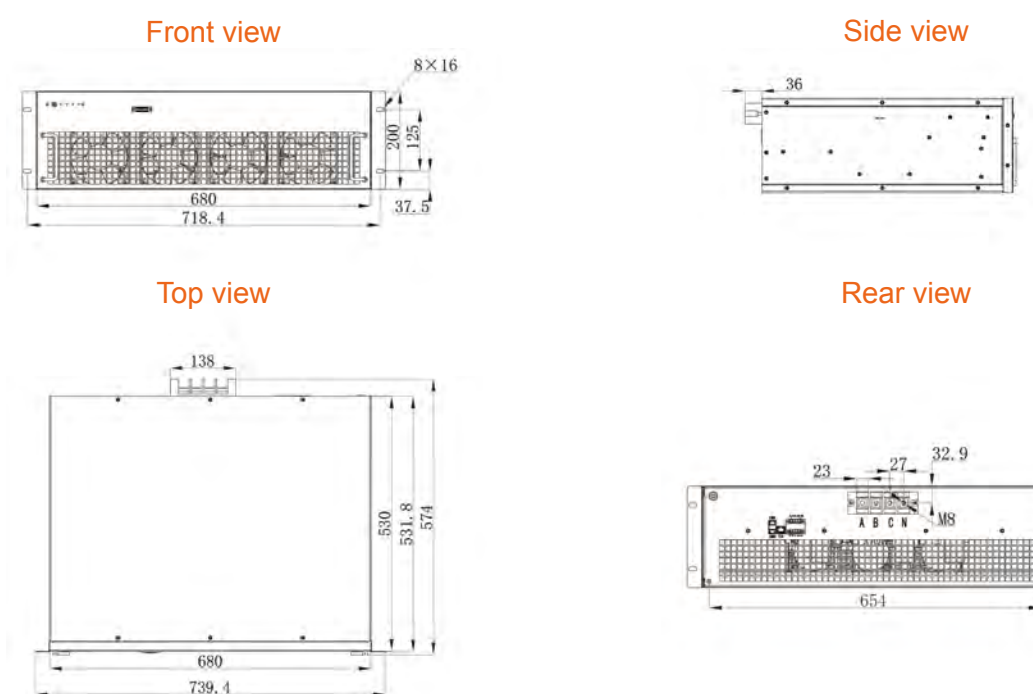

680 Width Rack Type Module Dimension Diagram (100A)

Front view

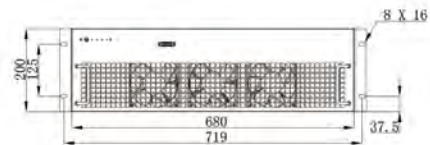

Side view

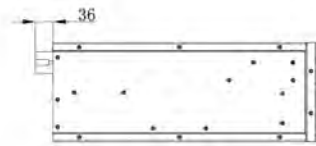

Top view

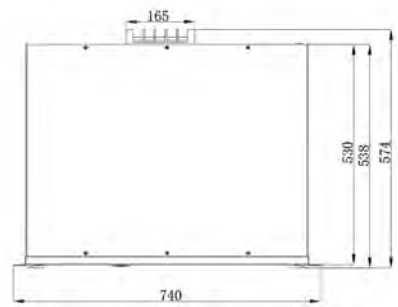

Rear view

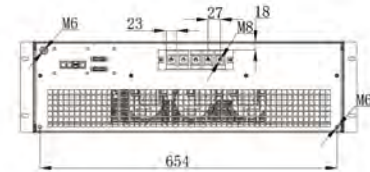

680 Width Wall Type Module Dimension Diagram (100kvar 150A)

Bottom view

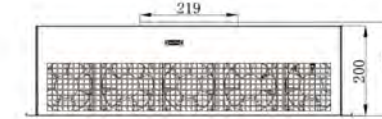

Top view

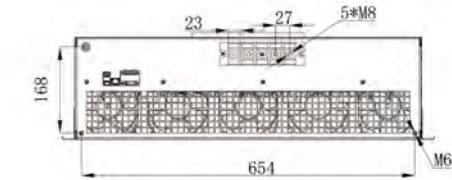

Front view

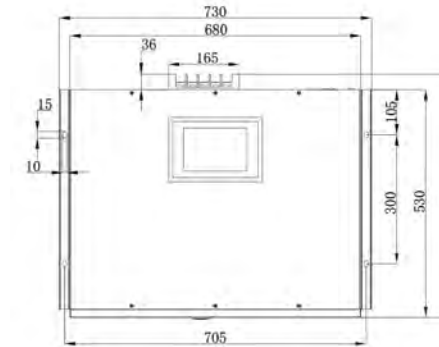

Side view

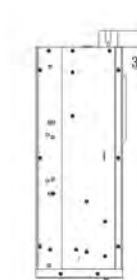

680 Width Wall Type Module Dimension Diagram (150kvar 200A)

Bottom view



Top view

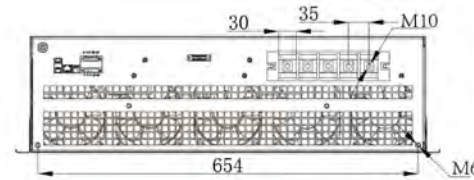

Front view

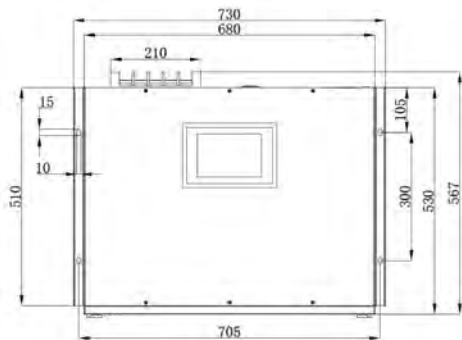

Side view

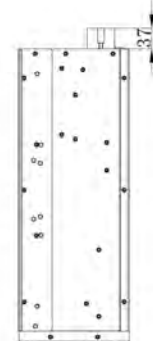

680 Width Wall Type Module Dimension Diagram (100A)

Bottom view

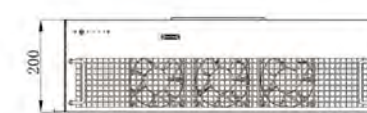

Top view

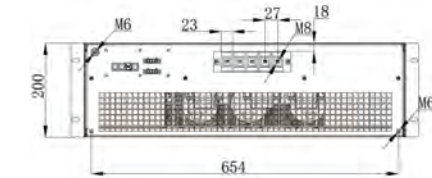

Front view

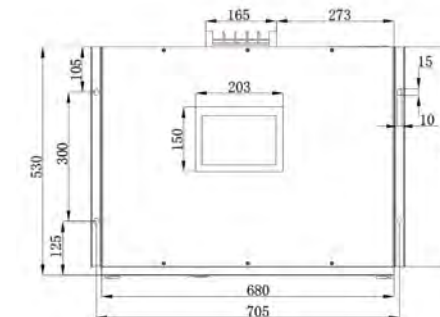

Side view

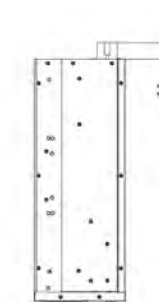

480 Width Rack Type Module Dimension Diagram (50kvar 50/75A)

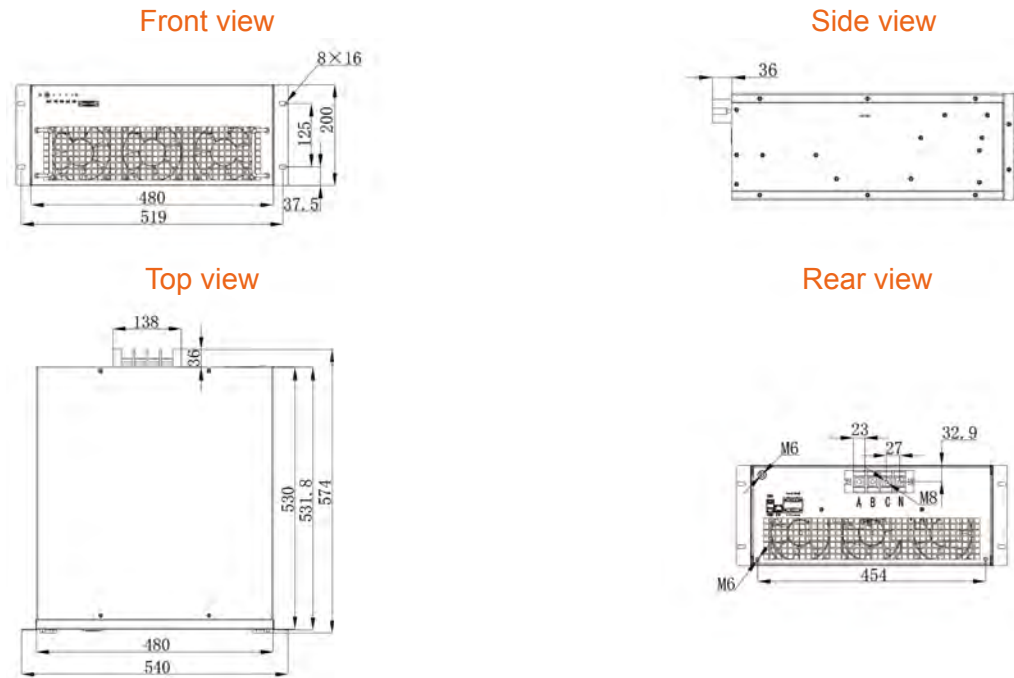

480 Width Wall Type Module Dimension Diagram (50kvar 50/75A)

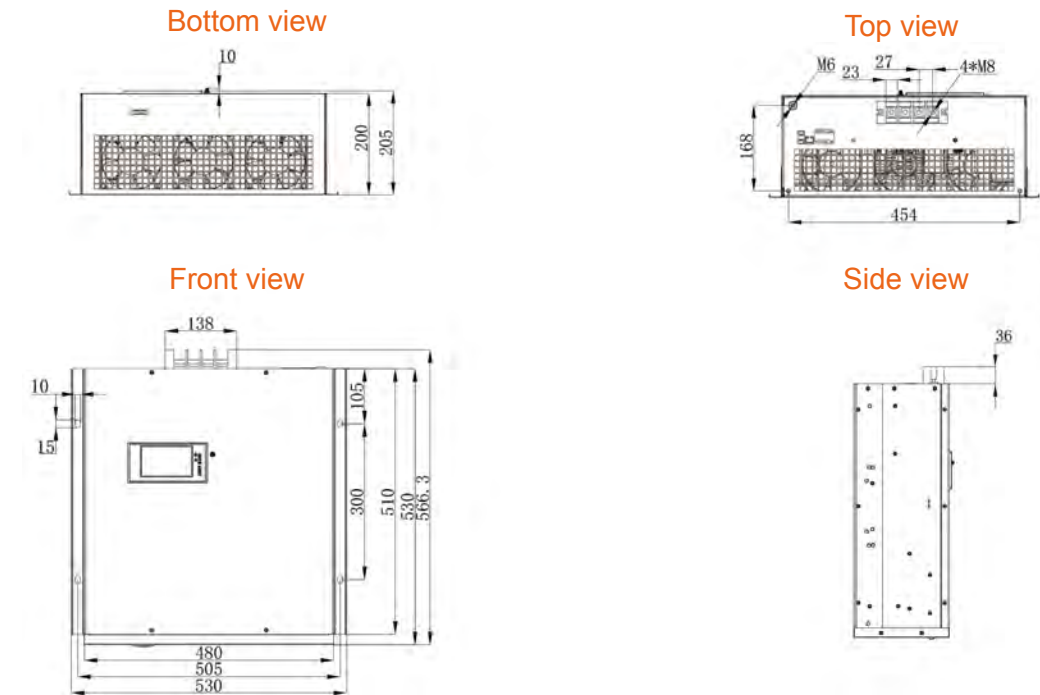

480 Width Rack Type Module Dimension Diagram (100A)

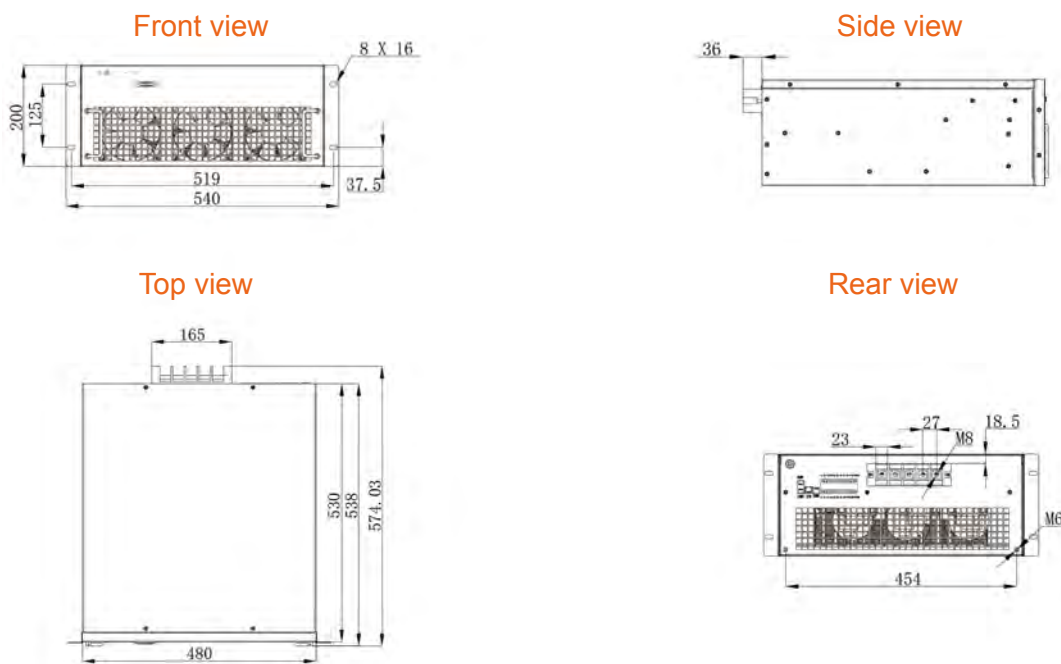

480 Width Wall Type Module Dimension Diagram (100A)

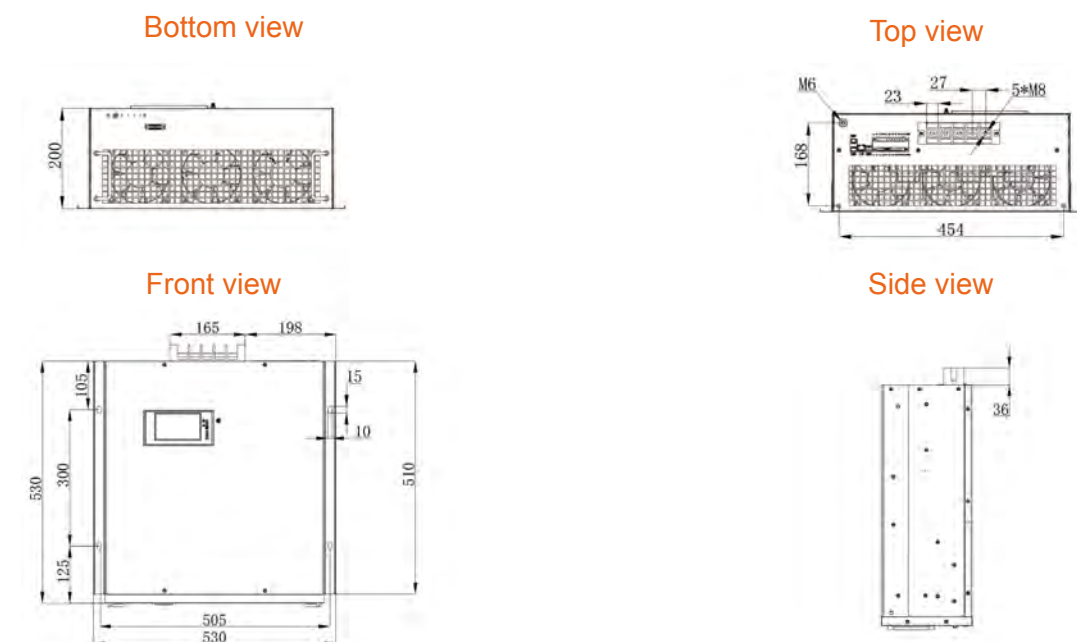

130 Height Rack Type Module Dimension Diagram (30kvar 35A)

Front view

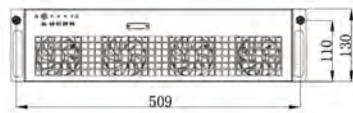

Side view

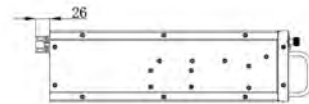

Top view

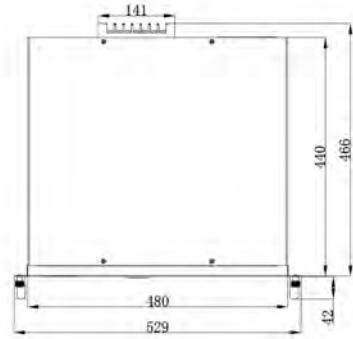

Rear view

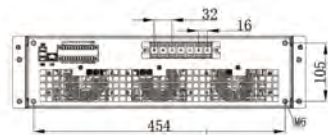

480/690V Rack Type Module Dimension Diagram (50/100 kvar 50/100A)

Front view

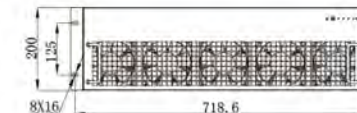

Side view

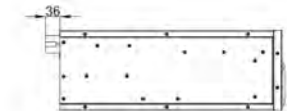

Top view

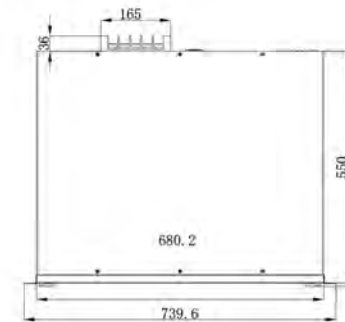

Rear view

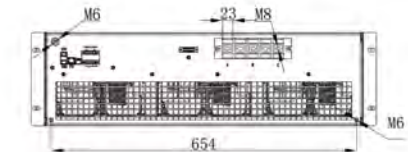

130 Height Wall Type Module Dimension Diagram (30kvar 35A)

Bottom view



Top view

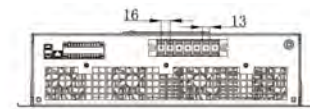

Front view

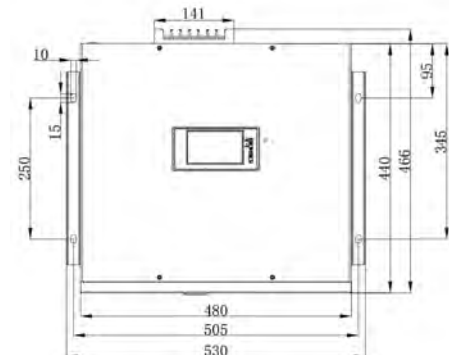

Side view



480/690V Wall Type Module Dimension Diagram (50/100 kvar 50/100A)

Front view

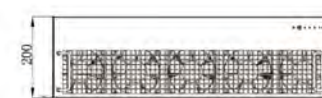

Side view

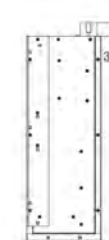

Front view

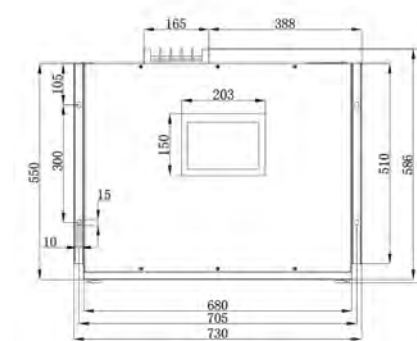

Top view

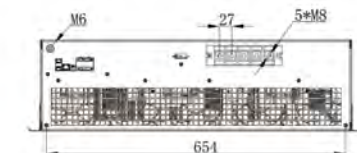

1.9 IKM AHF/SVG Design Scheme

Example of AHF Design Scheme

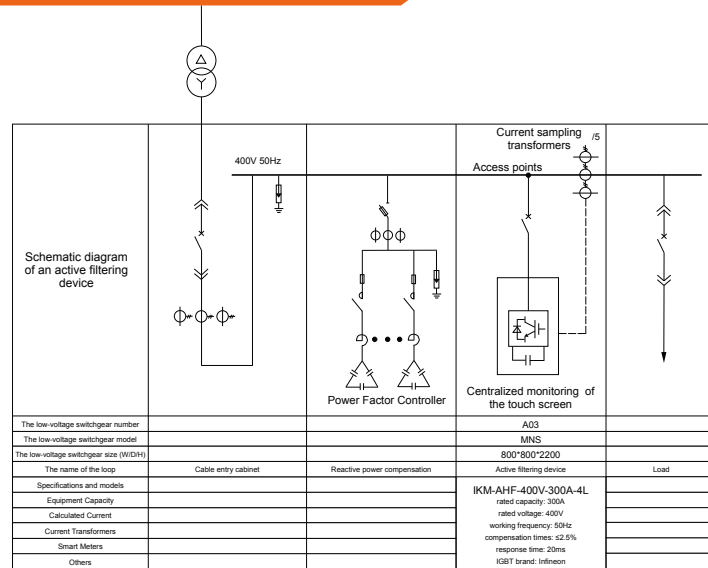

Note: The AHF active filter is located between the reactive power compensation cabinet and the feeder cabinet, and the current sampling CT is located on the front side of the load (i.e., the back side of the AHF active filter access point)

Example of SVG Design Scheme

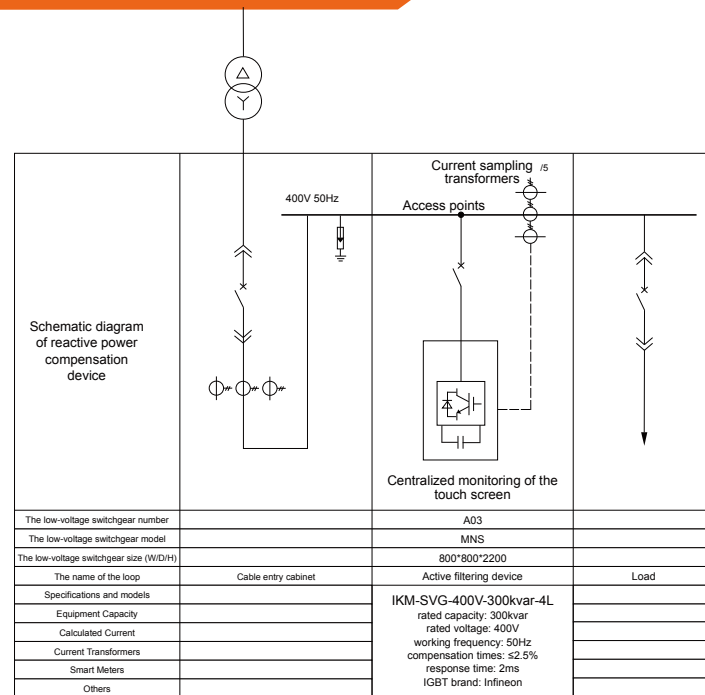

Note: The SVG reactive power compensation device is located in front of the feeder cabinet, and the current sampling CT is located on the front side of the load (i.e., behind the access point of the SVG reactive power compensation device)

1.10 IKM AHF/SVG Application Cases

Example 1: Metallurgical Industry

A certain metallurgical casting plant, mainly loaded with rectifier equipment such as intermediate frequency furnaces, generates a large amount of harmonics during operation. Due to the small capacity of the transformer, the power supply system exhibits weak grid characteristics when the load is large. The current harmonic distortion rate THD reaches 31%, resulting in a voltage distortion rate THDv of 21%, and a low power factor of 0.55. The on-site dust is severe and the ventilation conditions are poor, which is a typical complex and harsh working condition with "current harmonics + voltage harmonics + severe reactive power + dust pollution + high temperature". Ordinary equipment cannot function properly in this harsh power supply and working environment.

The addition of IKM series products to control power quality. Due to IKM's strong anti-interference and pollution resistance capabilities, after the installation and operation of the device, IKM has a significant control effect and stable and reliable operation. The comparison effect before and after governance is shown in the following figure.

After IKM-AHF was put into operation, the governance effect was very obvious, with voltage and current harmonics basically disappearing. THDi decreased to 4.3%, THDv decreased to 4.5%, and the power factor increased to 0.98.



Voltage and current in the metallurgical industry before governance

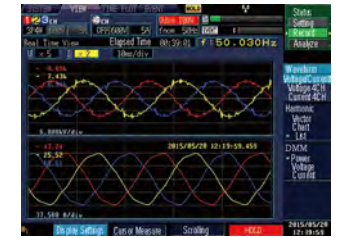

Voltage and current in the metallurgical industry after governance

Example 2: Welding Industry

A certain automobile manufacturing factory mainly carries suspended spot welding, robotic arms, assembly lines, motors, etc. The spot welding machine uses two-phase 380V power supply, and the current fluctuates greatly and the imbalance phenomenon is severe during operation. The A-phase current (yellow) is basically 0, while the B-phase and C-phase currents are 278A and 317A, respectively. The power factor is 0.52, and the current distortion rate is 40%. Because most of the unbalanced current flows through the neutral line, it causes severe heating in the neutral line. It is a typical complex and harsh working environment that combines "current harmonics+severe imbalance+severe reactive power".

After installing IKM-AHF, the current harmonics and reactive power were treated. The results were compared as follows: the three-phase current imbalance was basically eliminated, the neutral current was basically zero, the voltage and current harmonics were basically eliminated, THDi was reduced to 2.7%, and the power factor was increased to 0.98.



Voltage and current of spot welding machine before treatment

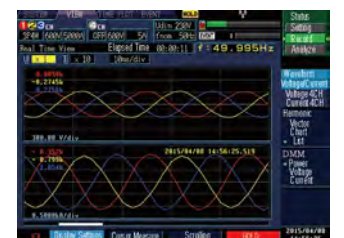

Voltage and current of spot welding machine after treatment

A technician in a white lab coat and safety glasses is working on a circuit board in a factory setting. The technician is wearing white gloves and is focused on the task. In the background, another technician is visible, also working. The scene is lit with blue and white lights, creating a professional and technical atmosphere.

02

**iKonMac Tech
Core Advantages**

2.1 Research and Development Strength

1 Master the Core Technology of AHF/SVG

- iKonMac specializes in R&D, with all products independently developed using core AHF and SVG technologies, including 7th-generation IGBT and full FPGA control chips.
- The Product Features a unique layered design, with industry-leading technical parameters and over 30 patents, including 5 inventions and 8 software copyrights.
- iKonMac continuously innovates to advance power quality products and drive industry progress.

Quality Comes From Professionalism



2 R&D Team Composition

- The R&D team of iKonMac is composed of high-tech professionals such as postdoctoral, doctoral, and master's degrees, with a R&D workforce accounting for 35%.
- The R&D team consists of positions such as Chief Engineer, Software, Control, Electronics, Electrical, Layout, Structure, Heat Flow, Testing, Process, etc. The R&D team is fully equipped.
- The R&D personnel mainly come from well-known universities such as Shanghai Jiaotong University, Zhejiang University, Xi'an Jiaotong University, Huazhong University of Science and Technology, and China University of Mining and Technology.

Focus On Creating Excellence



5 Proportion of R&D Investment

- The proportion of R&D investment is greater than 12% of annual sales revenue and continues to increase year by year.

4 R&D Management and Development Equipment

- iKonMac follows the IPD product development process and has partnered with Shanghai JiaoTong University to establish a joint laboratory. This collaboration enhances R&D management, accelerates the transformation of high-tech achievements, and boosts product innovation.
- We have advanced development and testing equipment, including vibration tables, programmable power supplies, IGBT testers, power quality analyzers, temperature change test boxes, and performance testing platforms for active filters and static reactive power generators.
- A dedicated project customization team provides R&D support for product adjustments in special projects.

3 Experienced R&D Team

- Core R&D personnel with 30 years of experience in power electronics development and over 15 years of experience in AHF/SVG development.
- The R&D team previously developed the medium voltage SVG in 2007 and put it into use in 2008. In 2009, a full cabinet AHF was developed and put into use the same year. Modular AHF was developed from 2010 to 2011 and put into use in 2011. In 2015, AHF/SVG was developed based on the core technology of the 7th generation IGBT and full FPGA, and was put into use in 2016. Industrial specific models were developed in 2019 and officially put into use in 2020.

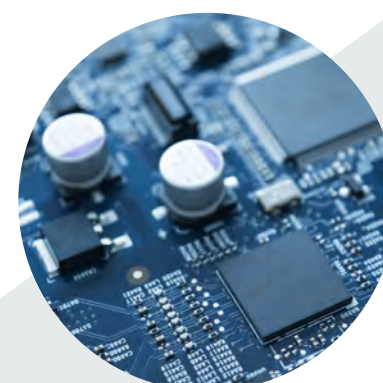

2.2 Product Core Advantages

1 Extremely High Anti Pollution Ability

The design adopts a layered structure, with the electronic layer and power components separated. The electronic layer provides effective insulation, moisture-proofing, and dust-proofing, while the power layer is cooled by fans. The electronic layer has an IP54 protection rating, and the module has a pollution resistance level of Class 3, making it suitable for harsh environments such as saline, humid, dusty, and corrosive gas conditions.

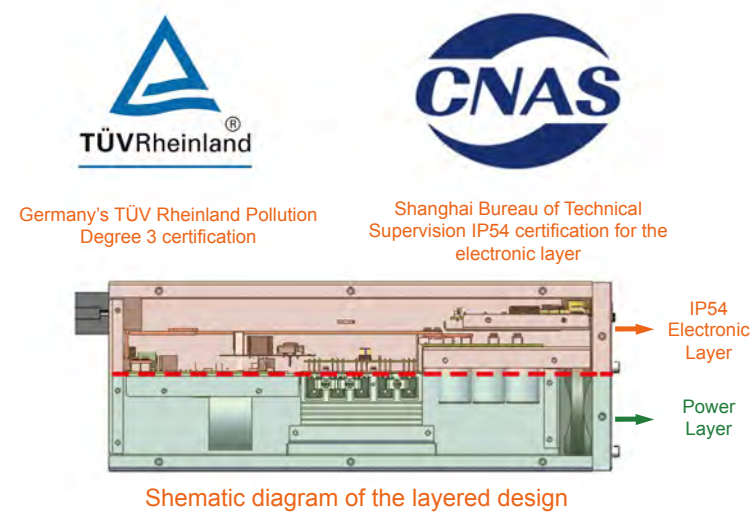

2 Adopting the 7th Generation IGBT from German Infineon

iKonMac's AHF/SVG uses the seventh generation IGBT, while most domestic AHF/SVG manufacturers still use the third generation. At the same time reducing switching loss by one-third and increasing the switching frequency by 2x40kHz, with parallel interleaving technology achieving an effective switching frequency of 80kHz. This challenges the control algorithm, as the main control chip needs to complete a PWM calculation within $1/80k=12.5\mu s$. iKonMac uses FPGA as the main control chip with parallel processing and multi-core CPU computing, allowing faster completion of control algorithms.

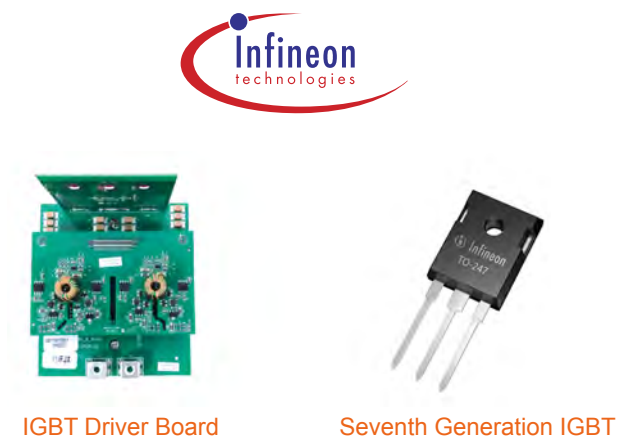

3 Adopting a Full FPGA Main Control Chip

Using the seventh-generation IGBT, doubling the switching frequency halves the control calculation time. Most manufacturers use DSP combined with CPLD or FPGA, but DSP's single-core serial processing can't meet the high switching frequency of the seventh generation IGBT. iKonMac's AHF/SVG uses an all FPGA control chip, with 8 million logic gates in the calculation program, equivalent to 16 parallel-running hardware CPU units.



4 Extremely Low Noise 60dB

Noise is crucial for user experience and comes from two main sources: first, heat dissipation, including airflow and fan noise. With the seventh generation IGBT, iKonMac reduces losses, adds temperature monitoring, and adjusts fan speed based on temperature, significantly lowering fan noise. Second, noise from the reactor is caused by high-frequency switching currents, with higher switching frequencies resulting in lower noise. iKonMac's seventh-generation IGBT achieves an effective switching frequency of 80kHz, compared to the common 20kHz, reducing module noise to under 60dB, while the industry standard is below 70dB.



5 Extremely Low Power Consumption 2.5%

The higher the active power loss, the more severe the heat generated by the device, and many failures in power electronics are due to internal heat damaging electronic components. Reducing active power loss is crucial, especially for large-scale applications like state grid industries. For AHF/SVG, power loss is a critical technical parameter. For instance, a 100A AHF module has a loss of 2.5%, which affects touch screen power, reactor heating, IGBT heating, etc., and reducing loss by even 0.1% is challenging.

iKonMac uses the seventh-generation IGBT, which reduces loss by 1/3 compared to the previous generation. By increasing the switching frequency to 40kHz, the inductance is halved, and with interleaved parallel technology, it is reduced even further. This results in an inductance value only 1/4 of similar products, leading to proportionally lower losses. As a result, iKonMac's AHF/SVG has a loss of less than 2.5%, while domestic products typically measure 3.5%.



Power Consumption \leq 2.5%

6 Extremely High Temperature Resistance of 55°C

For AHF/SVG, reliability comes from voltage and temperature resistance. iKonMac's AHF/SVG can run at full load in 55°C environments, thanks to the seventh-generation IGBT, which reduces loss and temperature rise, and the layered design that ensures effective heat dissipation and protection for the electronic layer.

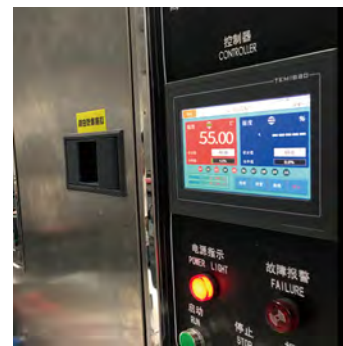

Full-load operation at an ambient temperature of 55°C.

7 Intelligent Compensation Efficient Prevention of Resonance

iKonMac's AHF/SVG adds a smart startup mode in the software to effectively avoid resonance points and protect the device's normal operation, enhancing product reliability. This allows the product to be used in more challenging electrical environments.

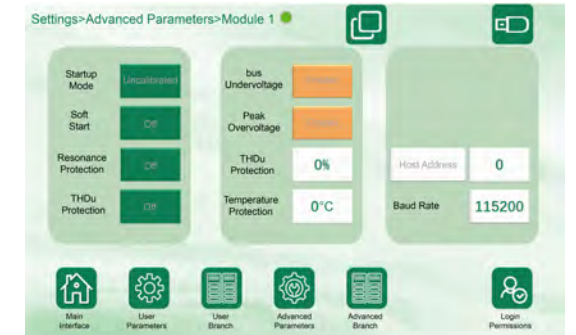

Smart Startup Mode

8 Extremely High Power Density 800A/675kvar

iKonMac's AHF/SVG adopts a standard modular design with an efficient layout and high power density. For a 800x800 standard cabinet, its capacity can reach 800A or 675kvar.



Specification	Max Power
Single Module/ Wall Mounted	200A/150kvar
600(W) * 600(D) Cabinet	300A/200kvar
800(W) * 600(D) Cabinet	400A/300kvar
600(W) * 800(D) Cabinet	600A/300kvar
800(W) * 800(D) Cabinet (Recommend Dimensions: 800(W) * 1000(D) Cabinet)	800A/675kvar

Maximum 800A/675kvar per cabinet

2.3 Quality Control

Incoming Inspection:

- All components are sourced from well-known international and domestic manufacturers.
- All materials undergo incoming inspection, with random checks for standard materials and full checks for critical ones.
- Key inspection equipment includes:
 - Bridge — for measuring inductance
 - Heat sink jig — for measuring hole positions on heat sinks
 - Inductor jig — for measuring inductor dimensions
 - Oven — for testing FPC terminal temperature resistance
 - Microscope — for inspecting PCBA soldering quality
 - High-precision multimeter — for measuring precision resistors (0.001)
- After all components are inspected, they are sent to the SMT factory for assembly.

ICT Testing

- The SMT factory conducts ICT testing on all completed PCBs to prevent soldering defects such as cold or missed solder joints.

FCT Testing

- Once the PCBs arrive at the company, full inspection is carried out with dedicated testing fixtures for each board

Assembly

- All assembly is done in an ESD-protected environment (ESD clothing, shoes, flooring, constant temperature and humidity chamber, ESD wristbands, ESD transit boxes, and all equipment grounded). Process inspections are conducted according to SOP.

Low-voltage Testing

- After assembly, products undergo 30V low-voltage communication testing on a custom automated test platform.

High-voltage Testing

- Next, products undergo 400V high-voltage on/off testing on a custom automated test platform.

Aging Test

- Full-load aging test of all modules for 24 hours.

Final Inspection

- Before shipment, the product undergoes a final inspection to check its operational status.



2.4 Service Competitiveness

Product Customization

- Custom brand silk printing
- Customized design for human-machine interface startup screen
- Customized shipping documentation
- Special projects with dedicated R&D technical support.

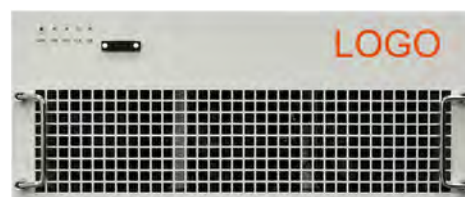

Power Quality Testing Services and Professional Solutions

- Provide power quality testing services
- Develop professional power quality management solutions
- Create reasonable corrective action plans
- Full-line technical support for solution implementation
- Provide project effectiveness reports and equipment operation reports.



Power Quality Issues:

Technical Consultation, Installation Guidance, Debugging, and Training Services

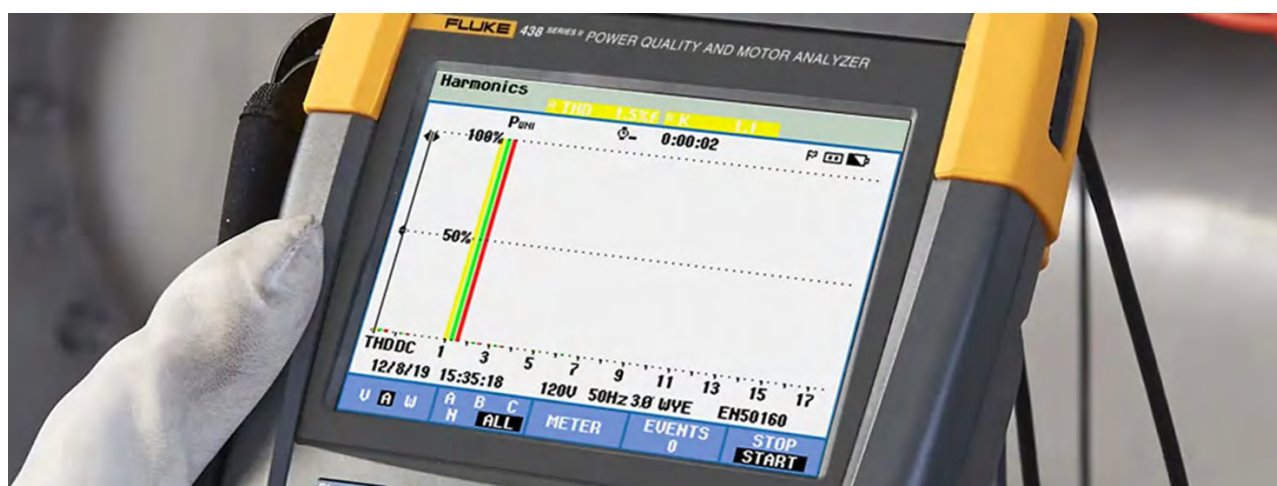

After-Sales Service Commitment

Supporting Documentation

We ensure product traceability with full documentation, including user manuals, product drawings, and technical info for each project.

Online-Remote Service

We offer remote technical support with a response time under 2 hours, and resolve issues within 24 hours. For unresolved issues, on-site technicians will be dispatched.

Post-Warranty Service

Lifetime maintenance after warranty, charging only for costs. A full maintenance plan is provided beyond warranty.

Service Records

We keep detailed records of every customer interaction, service, and feedback for quality analysis.

Preventive Inspections

Regular follow-ups and site inspections to ensure customer satisfaction.



iKonMac *Reliability at Our Core*